

Article number: 51030541000010

Description: Vibration damper GS-M2  
150x80x2000-10, NR shore 57

## Measures

---

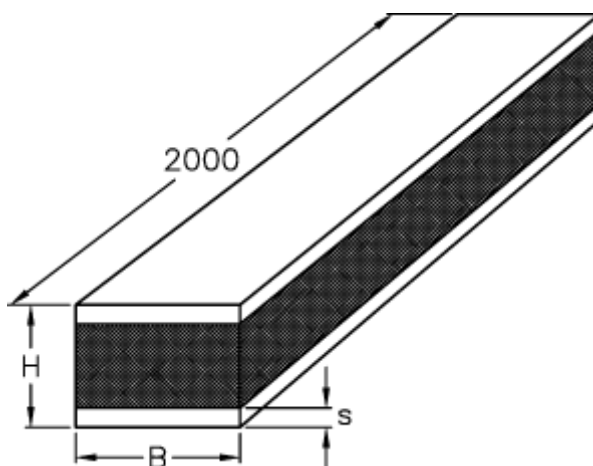

B = 150

H = 80

S = 10